

Coper

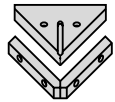

Notcher



Bar Cutter

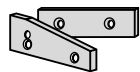

Shear Blades

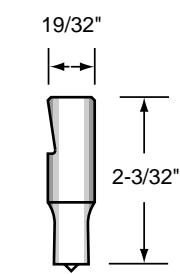

**BF10**  
Up to 9/16"

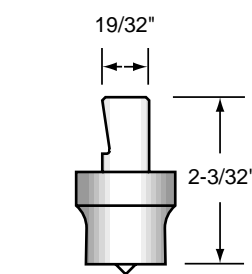

**BF10**  
Up to 1-1/4"

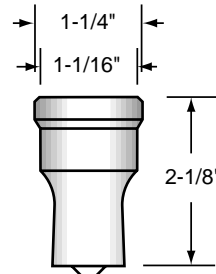

**119M H1**

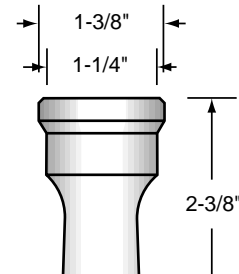

**121M H2**

BF10 uses a H1 die. All oblong, square, rectangular and hex dies have 2 drill spots. Punches have 1 keyway.

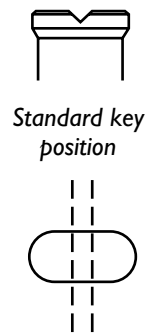

Standard key position

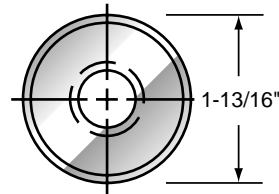

**313 H1**

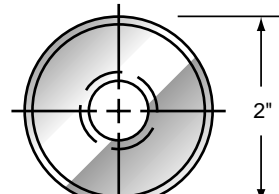

**317 H2**

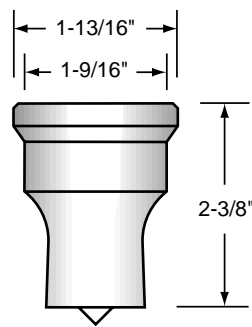

**A3**

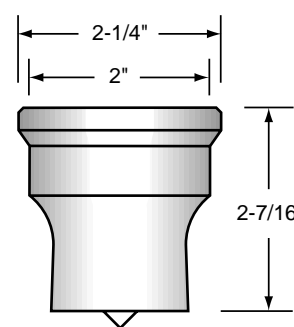
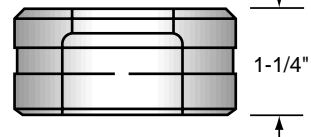
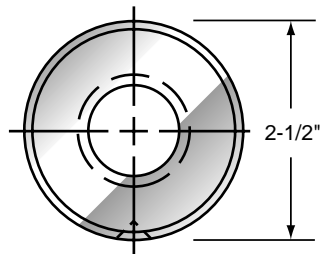

**A4**

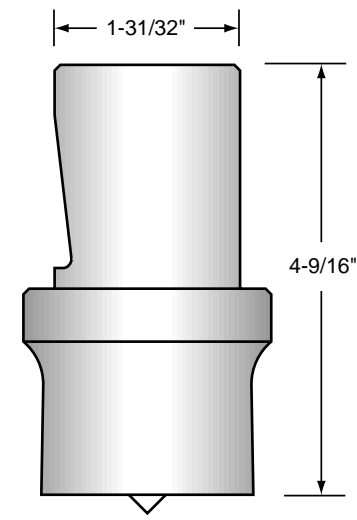
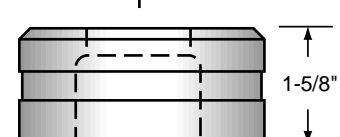
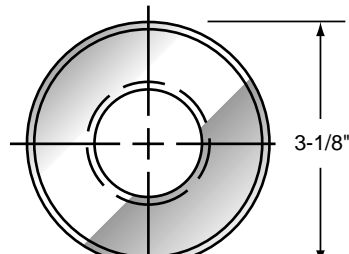

**COUPLING NUTS - H1, H2, H3, H4**

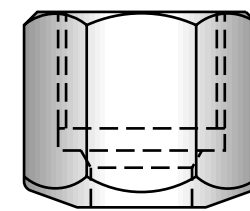

**DIE REDUCER**

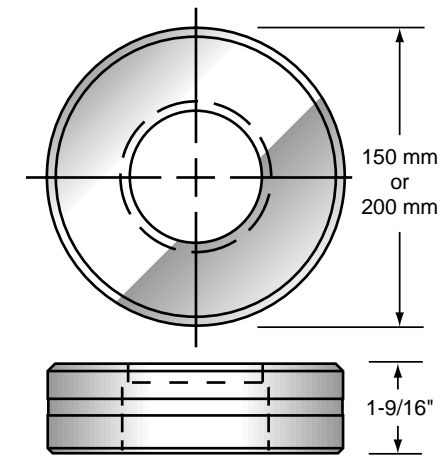
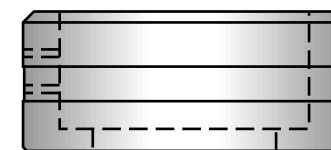

**A5**

**BEVEL CORRUGATED**

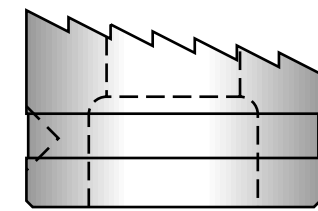

**PUNCH REDUCING SLEEVES**

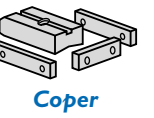
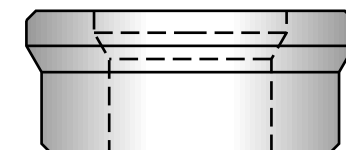

Coper

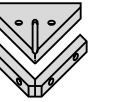

Notcher

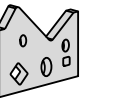

Bar Cutter

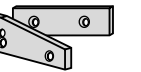

Shear Blades